

# TABLES

## Rounded edge tables

The rounded edge range meet the specifications of the architects and kitchen consultants for the tenders



SCAN ME  
and download all the technical  
datasheets of the range!



### FOCUS ON...



Welded corners



Backslash with  
slope edge

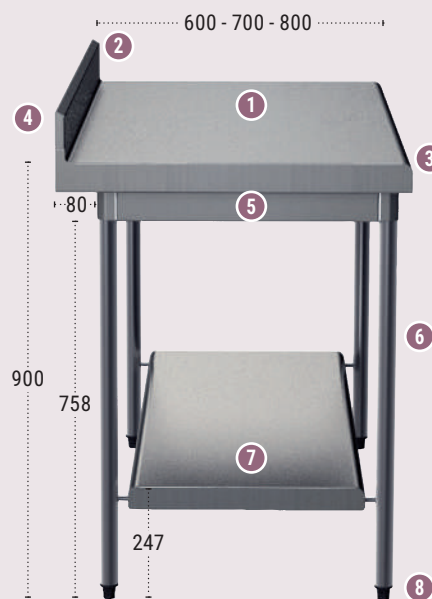

- 1 Work top in AISI 304L stainless steel 1.5 mm thickness, reinforced with a 19 mm thick water-resistant melamine panel
- 2 10 mm curve
- 3 Welded corners 20 mm rounded edge, 60 mm dropped edge
- 4 Backslash with 30° slope edge 100 x 20 mm (optional: rear closed)
- 5 All stainless steel panel
- 6 Tubular stainless steel feet, Ø 38 mm, collapsible
- 7 Rounded edge removable bottom shelf depth 475 mm Optional
- 8 ABS feet adjustable up to 30 mm



Bottom shelf slots into the legs in a single movement.



## turn'fix

**Tool-free mounting of the legs,  
easy and quick**

- 1 Easier
- 2 Quicker
- 3 More robust

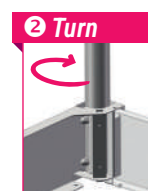
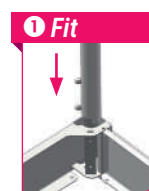



## Rounded edge collapsible tables

### On feet

- ABS feet adjustable up to 30 mm
- Maximum load : 150 kg distributed
- 6 feet for length 2400 mm

#### Standard



HEIGHT  
900 mm

CENTRAL TABLES

CENTRAL TABLES  
+ BOTTOM SHELF

TABLES WITH BACKSPLASH

TABLES WITH BACKSPLASH  
+ BOTTOM SHELF

#### WIDTH 600

L x D mm	Kg	Ref.	Kg	Ref.	Kg	Ref.	Kg	Ref.
600 x 600	20	TAC606	23.6	TACEG606	20.5	TAD606	24.2	TADEG606
1000 x 600	28	TAC610	34.1	TACEG610	28.6	TAD610	34.3	TADEG610
1200 x 600	32.5	TAC612	39.4	TACEG612	32.7	TAD612	39.5	TADEG612
1400 x 600	36	TAC614	44.9	TACEG614	36.7	TAD614	44.7	TADEG614
1500 x 600	38.7	TAC615	47	TACEG615	38.6	TAD615	47.5	TADEG615
1600 x 600	40.7	TAC616	49.7	TACEG616	40.9	TAD616	49.9	TADEG616
1800 x 600	45.3	TAC618	55.5	TACEG618	44.9	TAD618	55.2	TADEG618
2000 x 600	49.4	TAC620	60.7	TACEG620	48.9	TAD620	60.2	TADEG620
2200 x 600	53.5	TAC622	66.3	TACEG622	52.9	TAD622	65.7	TADEG622

#### WIDTH 700

L x D mm	Kg	Ref.	Kg	Ref.	Kg	Ref.	Kg	Ref.
700 x 700	25	TAC707	30	TACEG707	24.6	TAD707	29.7	TADEG707
800 x 700	27.2	TAC708	33	TACEG708	26.9	TAD708	32.7	TADEG708
1000 x 700	31.8	TAC710	38.8	TACEG710	31.4	TAD710	38.5	TADEG710
1200 x 700	36.3	TAC712	44.6	TACEG712	36.1	TAD712	44.4	TADEG712
1400 x 700	41	TAC714	50.6	TACEG714	40.7	TAD714	50.3	TADEG714
1500 x 700	43.6	TAC715	54.1	TACEG715	43	TAD715	53.5	TADEG715
1600 x 700	45.6	TAC716	56.8	TACEG716	45.3	TAD716	56.5	TADEG716
1800 x 700	50	TAC718	62.8	TACEG718	50	TAD718	62.5	TADEG718
2000 x 700	55	TAC720	68.7	TACEG720	54.6	TAD720	68.5	TADEG720
2200 x 700	59.8	TAC722	75.2	TACEG722	59.3	TAD722	74.8	TADEG722
2400 x 700	64	TAC724*	77	TACEG724*	65.4	TAD724*	82	TADEG724*

Shipping within 48h

\*6 feet

#### WIDTH 800

L x D mm	Kg	Ref.	Kg	Ref.	Kg	Ref.	Kg	Ref.
800 x 800	30	TAC808	38	TACEG808	33	TAD808	39	TADEG808
1000 x 800	36	TAC810	43	TACEG810	37	TAD810	44	TADEG810
1200 x 800	38	TAC812	45	TACEG812	39	TAD812	46	TADEG812
1400 x 800	41	TAC814	50	TACEG814	42	TAD814	51	TADEG814
1500 x 800	42.5	TAC815	52	TACEG815	43	TAD815	53	TADEG815
1600 x 800	44	TAC816	54	TACEG816	45	TAD816	57	TADEG816
1800 x 800	46	TAC818	58	TACEG818	48	TAD818	61	TADEG818
2000 x 800	49	TAC820	62	TACEG820	51	TAD820	64	TADEG820
2200 x 800	52	TAC822	66	TACEG822	54	TAD822	68	TADEG822

► CUSTOMIZED / See collapsible tables on feet page 41

OPTIONS  
pages 58-59



ACCESSORIES  
page 60





## Rounded edge collapsible tables

### On polyamid castors

- Swivelling castors Ø 125 mm : 2 with brake, 2 without brake
- Maximum load : 100 kg distributed

**Standard**



HEIGHT  
900 mm

CENTRAL TABLES

CENTRAL TABLES  
+ BOTTOM SHELF

TABLES WITH BACKSPLASH

TABLES WITH BACKSPLASH  
+ BOTTOM SHELF

**WIDTH 600**

L x D mm	Kg	Ref.	Kg	Ref.	Kg	Ref.	Kg	Ref.
600 x 600	21.5	TAC606RP	25	TACEG606RP	21.9	TAD606RP	25.5	TADEG606RP
1000 x 600	29	TAC610RP	35.5	TACEG610RP	30	TAD610RP	35.6	TADEG610RP
1200 x 600	34	TAC612RP	40.7	TACEG612RP	34.1	TAD612RP	40.8	TADEG612RP
1400 x 600	38.3	TAC614RP	46.2	TACEG614RP	38.2	TAD614RP	46	TADEG614RP
1500 x 600	40.1	TAC615RP	48.8	TACEG615RP	40.1	TAD615RP	48.8	TADEG615RP
1600 x 600	42.1	TAC616RP	51	TACEG616RP	42.3	TAD616RP	51.2	TADEG616RP
1800 x 600	46.7	TAC618RP	56.9	TACEG618RP	46.4	TAD618RP	56.5	TADEG618RP
2000 x 600	50.8	TAC620RP	62	TACEG620RP	50.3	TAD620RP	61.5	TADEG620RP
2200 x 600	55	TAC622RP	67.6	TACEG622RP	54.3	TAD622RP	67	TADEG622RP

**WIDTH 700**

L x D mm	Kg	Ref.	Kg	Ref.	Kg	Ref.	Kg	Ref.
700 x 700	26.4	TAC707RP	31.4	TACEG707RP	26	TAD707RP	31	TADEG707RP
800 x 700	28.6	TAC708RP	34.4	TACEG708RP	28.3	TAD708RP	34	TADEG708RP
1000 x 700	33.2	TAC710RP	40.1	TACEG710RP	32.9	TAD710RP	39.8	TADEG710RP
1200 x 700	37.8	TAC712RP	45.9	TACEG712RP	37.5	TAD712RP	45.7	TADEG712RP
1400 x 700	42.4	TAC714RP	51.9	TACEG714RP	42.1	TAD714RP	51.6	TADEG714RP
1500 x 700	45	TAC715RP	55.4	TACEG715RP	44.5	TAD715RP	54.8	TADEG715RP
1600 x 700	47	TAC716RP	58	TACEG716RP	46.8	TAD716RP	57.8	TADEG716RP
1800 x 700	50	TAC718RP	64.2	TACEG718RP	51.4	TAD718RP	63.8	TADEG718RP
2000 x 700	56	TAC720RP	70	TACEG720RP	56.1	TAD720RP	69.8	TADEG720RP
2200 x 700	61.2	TAC722RP	76.6	TACEG722RP	60.7	TAD722RP	76.1	TADEG722RP
2400 x 700	65.1	TAC724RP	78	TACEG724RP	65.4	TAD724RP	82.1	TADEG724RP

Shipping within 48h

**WIDTH 800**

L x D mm	Kg	Ref.	Kg	Ref.	Kg	Ref.	Kg	Ref.
800 x 800	33	TAC808RP	39	TACEG808RP	34	TAD808RP	40	TADEG808RP
1000 x 800	37	TAC810RP	44	TACEG810RP	38	TAD810RP	45	TADEG810RP
1200 x 800	39	TAC812RP	46	TACEG812RP	40	TAD812RP	47	TADEG812RP
1400 x 800	42	TAC814RP	51	TACEG814RP	43	TAD814RP	52	TADEG814RP
1500 x 800	43.5	TAC815RP	53	TACEG815RP	44	TAD815RP	54	TADEG815RP
1600 x 800	45	TAC816RP	55	TACEG816RP	46	TAD816RP	58	TADEG816RP
1800 x 800	47	TAC818RP	59	TACEG818RP	49	TAD818RP	62	TADEG818RP
2000 x 800	50	TAC820RP	63	TACEG820RP	52	TAD820RP	65	TADEG820RP
2200 x 800	52	TAC822RP	66	TACEG822RP	54	TAD822RP	68	TADEG822RP

► **CUSTOMIZED** / See collapsible tables on polyamid castors page 41

**OPTIONS**  
pages 58-59



**ACCESSORIES**  
page 60





## Rounded edge bottom shelves (individually packed)

- Bottom shelf slots into the legs in a tool-free single movement

### TOOL-FREE ASSEMBLY

Bottom shelf slots into the legs in a single movement



## Solid bottom shelf

- All stainless steel
- Edges 60 mm dropped



	DEPTH 600		DEPTH 700		DEPTH 800	
For table length mm	Kg	Ref.	Kg	Ref.	Kg	Ref.
600	4.8	<b>EGAZ606</b>		-		-
700		-	5.2	<b>EGAZ707</b>		-
800		-	7	<b>EGAZ708</b>		<b>EGAZ808</b>
1000	6	<b>EGAZ610</b>	7.5	<b>EGAZ710</b>	8.8	<b>EGAZ810</b>
1200	7	<b>EGAZ612</b>	8	<b>EGAZ712</b>	10	<b>EGAZ812</b>
1400	8	<b>EGAZ614</b>	10	<b>EGAZ714</b>	11.4	<b>EGAZ814</b>
1500	9	<b>EGAZ615</b>	11	<b>EGAZ715</b>	12	<b>EGAZ815</b>
1600	9.6	<b>EGAZ616</b>	11.5	<b>EGAZ716</b>	12.6	<b>EGAZ816</b>
1800	10.8	<b>EGAZ618</b>	12	<b>EGAZ718</b>	13.8	<b>EGAZ818</b>
2000	12	<b>EGAZ620</b>	13	<b>EGAZ720</b>	15	<b>EGAZ820</b>

Shipping within 48h

## Racks bottom shelf

- All stainless steel
- Tubular 35 x 35 mm

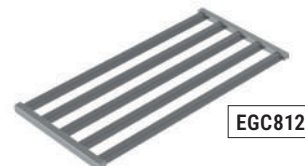
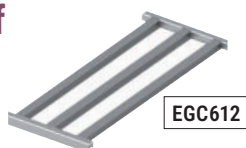

	DEPTH 600		DEPTH 700		DEPTH 800	
For table length mm	Kg	Ref.	Kg	Ref.	Kg	Ref.
600	3.4	<b>EGC606</b>		-		-
700		-	5	<b>EGC707</b>		-
800		-	7	<b>EGC708</b>	7.1	<b>EGC808</b>
1000	5.2	<b>EGC610</b>	7	<b>EGC710</b>	8.6	<b>EGC810</b>
1200	6	<b>EGC612</b>	8.2	<b>EGC712</b>	10.2	<b>EGC812</b>
1400	6.5	<b>EGC614</b>	9.4	<b>EGC714</b>	11.8	<b>EGC814</b>
1500	7	<b>EGC615</b>	10	<b>EGC715</b>	12.6	<b>EGC815</b>
1600	7.4	<b>EGC616</b>	10.7	<b>EGC716</b>	13.4	<b>EGC816</b>
1800	8	<b>EGC618</b>	12	<b>EGC718</b>	14.9	<b>EGC818</b>
2000	9	<b>EGC620</b>	13.2	<b>EGC720</b>	16.5	<b>EGC820</b>
2200	9.5	<b>EGC622</b>	14.5	<b>EGC722</b>	18.1	<b>EGC822</b>





## Customized rounded edge collapsible tables

### On feet

- ABS feet adjustable up to 30 mm
- Maximum load : 150 kg distributed

#### Customized



HEIGHT  
900 mm

CENTRAL TABLES

CENTRAL TABLES  
+ BOTTOM SHELF

TABLES WITH  
BACKSPLASH

TABLES WITH  
BACKSPLASH  
+ BOTTOM SHELF

#### WIDTH 600 TO 800 MM

L x D mm	Legs	Ref.	Ref.	Ref.	Ref.
600 to 1000	4	TAC7-10	TACEG7-10	TAD7-10	TADEG7-10
1001 to 1200	4	TAC7-12	TACEG7-12	TAD7-12	TADEG7-12
1201 to 1400	4	TAC7-14	TACEG7-14	TAD7-14	TADEG7-14
1401 to 1600	4	TAC7-16	TACEG7-16	TAD7-16	TADEG7-16
1601 to 1800	4	TAC7-18	TACEG7-18	TAD7-18	TADEG7-18
1801 to 2000	4	TAC7-20	TACEG7-20	TAD7-20	TADEG7-20
2001 to 2200	4	TAC7-22	TACEG7-22	TAD7-22	TADEG7-22
2201 to 2400	6	TAC7-24	TACEG7-24	TAD7-24	TADEG7-24
2401 to 2600	6	TAC7-26	TACEG7-26	TAD7-26	TADEG7-26
2601 to 2800	6	TAC7-28	TACEG7-28	TAD7-28	TADEG7-28

## Customized rounded edge collapsible tables

### On polyamid castors

- Swivelling castors Ø 125 mm : 2 with brake, 2 without brake
- Maximum load : 100 kg distributed

#### Customized



HEIGHT  
900 mm

CENTRAL TABLES

CENTRAL TABLES  
+ BOTTOM SHELF

TABLES WITH  
BACKSPLASH

TABLES WITH  
BACKSPLASH  
+ BOTTOM SHELF

#### WIDTH 600 TO 800 MM

L x D mm	Legs	Ref.	Ref.	Ref.	Ref.
600 to 1000	4	TAC7-10RP	TACEG7-10RP	TAD7-10RP	TADEG7-10RP
1001 to 1200	4	TAC7-12RP	TACEG7-12RP	TAD7-12RP	TADEG7-12RP
1201 to 1400	4	TAC7-14RP	TACEG7-14RP	TAD7-14RP	TADEG7-14RP
1401 to 1600	4	TAC7-16RP	TACEG7-16RP	TAD7-16RP	TADEG7-16RP
1601 to 1800	4	TAC7-18RP	TACEG7-18RP	TAD7-18RP	TADEG7-18RP
1801 to 2000	4	TAC7-20RP	TACEG7-20RP	TAD7-20RP	TADEG7-20RP
2001 to 2200	4	TAC7-22RP	TACEG7-22RP	TAD7-22RP	TADEG7-22RP
2201 to 2400	6	TAC7-24RP	TACEG7-24RP	TAD7-24RP	TADEG7-24RP
2401 to 2600	6	TAC7-26RP	TACEG7-26RP	TAD7-26RP	TADEG7-26RP
2601 to 2800	6	TAC7-28RP	TACEG7-28RP	TAD7-28RP	TADEG7-28RP

OPTIONS  
pages 58-59



ACCESSORIES  
page 60





Time saving for the floor cleaning

## Suspended and semi-suspended collapsible tables

- Work top : in AISI 304L 1.5 mm thickness stainless steel, reinforced with a 19 mm thick water-resistant melamine panel
- Edges : 20 mm rounded , 60 mm drop edge, welded corners
- Rear backsplash: 100 x 20 mm rounded on the base and at a 30° angle, 10mm curve (optional: rear closed)
- Frame in bent round stainless steel tubes Ø 38mm
- Frame fixed to the wall by screwing through the wall plates

- Top attaches to the wall by screwing of the rear profile

### Semi-suspended version:

- Frame in bent stainless steel tube Ø 38 mm with welded set-back front leg
- ABS feet adjustable up to 30 mm

**Standard**



SUSPENDED TABLES



SEMI-SUSPENDED TABLES

### WIDTH 600 MM

L x D mm	Kg	Ref.	Kg	Ref.
1000 x 600	26	TAS610	27	TASS610
1200 x 600	30	TAS612	31	TASS612
1400 x 600	34	TAS614	35	TASS614
1500 x 600	36	TAS615	37	TASS615
1600 x 600	38	TAS616	39	TASS616
1800 x 600	42	TAS618	43	TASS618
2000 x 600	46	TAS620	47	TASS620

### WIDTH 700 MM

L x D mm	Kg	Ref.	Kg	Ref.
1000 x 700	30	TAS710	31	TASS710
1200 x 700	34	TAS712	35	TASS712
1400 x 700	38	TAS714	39	TASS714
1500 x 700	40	TAS715	41	TASS715
1600 x 700	42	TAS716	43	TASS716
1800 x 700	46	TAS718	47	TASS718
2000 x 700	50	TAS720	51	TASS720

## Suspended and semi-suspended Chef tables

- Same as suspended and semi-suspended tables, + sink 400 x 400 x 250 mm with plug and overflow pipe
- Tap hole Ø 31 mm
- PVC U-bend included

**Standard**



SUSPENDED CHEF TABLES



SEMI-SUSPENDED CHEF TABLES



### WIDTH 700 MM

L x D mm	Kg	Ref.	Ref.	Kg	Ref.	Ref.
700 x 700	29	BAC DU CHEF : TASH07		30	BAC DU CHEF : TASSH07	
1200 x 700	35	TASH12CD	TASH12CG	46	TASSH12CD	TASSH12CG
1400 x 700	39	TASH14CD	TASH14CG	40	TASSH14CD	TASSH14CG
1500 x 700	41	TASH15CD	TASH15CG	42	TASSH15CD	TASSH15CG
1600 x 700	43	TASH16CD	TASH16CG	44	TASSH16CD	TASSH16CG
1800 x 700	47	TASH18CD	TASH18CG	48	TASSH18CD	TASSH18CG
2000 x 700	51	TASH20CD	TASH20CG	52	TASSH20CD	TASSH20CG

Shipping within 48h

OPTIONS  
pages 58-59



ACCESSORIES  
page 60





## Rounded edge Chef tables

- Welded stainless steel sink, L 400 x W 400 x H 250 mm
- Supplied with plug and overflow pipe
- Tap hole Ø 31 mm (optional cover)





- 1 Work top in AISI 304L stainless steel 1.5 mm thickness, reinforced with a 19 mm thick water-resistant melamine panel
- 2 Welded corners - Front rounded edge 20 mm radius with 60 mm drop edge
- 3 Sink and tap hole
- 4 Backsplash with 30° slope edge (H 100 x D 20 mm) (optional: rear closed) - 10 mm curve
- 5 Stainless steel side panels
- 6 Tubular stainless steel legs, Ø 38 mm, collapsible,
- 7 Rounded edge bottom shelf slots into the legs, tool-free, optional
- 8 ABS feet adjustable up to 30 mm



Mounting of the legs Turn'fix by fitting into the stainless steel frame. Bottom shelf slots into the legs in a single movement

### Standard

HEIGHT 900 mm		 SINK ON THE RIGHT	 SINK ON THE LEFT
L x D mm	Kg	Ref.	Ref.
700 x 700	22	<b>TAH07</b>	
1200 x 700	36	<b>TAH12CD</b>	<b>TAH12CG</b>
1400 x 700	41	<b>TAH14CD</b>	<b>TAH14CG</b>
1500 x 700	43.5	<b>TAH15CD</b>	<b>TAH15CG</b>
1600 x 700	46	<b>TAH16CD</b>	<b>TAH16CG</b>
1800 x 700	54	<b>TAH18CD</b>	<b>TAH18CG</b>
2000 x 700	60	<b>TAH20CD</b>	<b>TAH20CG</b>

### OPTIONAL: BOTTOM SHELF

Kg	Ref.
5	<b>EGA707</b>
8	<b>EGA712</b>
9.5	<b>EGA714</b>
10.2	<b>EGA715</b>
11	<b>EGA716</b>
12.5	<b>EGA718</b>
13.5	<b>EGA720</b>

\*Only if sold with TAH tables

 Shipping within 48h

## Rounded edge Chef tables

- Tap hole Ø 31 mm, available without hole or with 2 holes (ref. SPST, SPBT - no extra-cost) page 59

### Customized

HEIGHT 900 mm | CHEF TABLE WITH BACKSPLASH - 1 SINK\*

### WIDTH 600 TO 800

L x D mm	Feet	Ref.
600 to 1000	4	<b>TAH-10C</b>
1001 to 1200	4	<b>TAH-12C</b>
1201 to 1400	4	<b>TAH-14C</b>
1401 to 1600	4	<b>TAH-16C</b>
1601 to 1800	4	<b>TAH-18C</b>
1801 to 2000	4	<b>TAH-20C</b>
2001 to 2200	4	<b>TAH-22C</b>
2201 to 2400	6	<b>TAH-24C</b>
2401 to 2600	6	<b>TAH-26C</b>
2601 to 2800	6	<b>TAH-28C</b>

\* Sink on the right or on the left, please notify on the order



- > Stainless steel panels on the front and both sides for customized rounded edge chef tables : option POPT04 page 58
- > Suspended or semi-suspended chef tables : options TOP16 or TOP17 page 58

### OPTIONAL: CUSTOMIZED ROUNDED EDGE BOTTOM SHELF

Ref.
<b>EGA7-10</b>
<b>EGA7-12</b>
<b>EGA7-14</b>
<b>EGA7-16</b>
<b>EGA7-18</b>
<b>EGA7-20</b>
<b>EGA7-22</b>
<b>EGA7-24</b>
<b>EGA7-26</b>
<b>EGA7-28</b>

\*Only if sold with TAH tables

OPTIONS  
pages 58-59



ACCESSORIES  
page 60







## Chef furniture with rounded edge



**MH214CD + PLAROBIML**  
(tap p. 60)

- In AISI 304L stainless steel
- Half-sized back to insert pipework
- 2 hanging sliding doors - Lock - No shelf
- Work top : in AISI 304L 1.5 mm thickness stainless steel, reinforced with a 19 mm thick water-resistant melamine panel - Welded corners - 20 mm front edge radius, 60 mm drop edge
- Backsplash 100 x 20 mm rounded on the base and with a 30° slope edge, welded on each side of the backsplash
- Sink : stainless steel, welded, L x D x H : 400 x 400 x 250 mm
- Supplied with plug, simple overflow pipe and PVC U bend.
- Tap hole Ø 31 mm (optional cover)
- Black ABS feet H 155 mm adjustable up to 70 mm

Standard		SINGLE PANEL DOORS AND SIDES		WITH DOUBLE PANEL DOORS AND SIDES	
		 SINK ON THE RIGHT	 SINK ON THE LEFT	 SINK ON THE RIGHT	 SINK ON THE LEFT
L x D x H mm	Kg	Ref.	Ref.	Kg	Ref.
1200 x 700 x 900	48	<b>MH212CD</b>	<b>MH212CG</b>	59	<b>MH312CD</b>
1400 x 700 x 900	54	<b>MH214CD</b>	<b>MH214CG</b>	66	<b>MH314CD</b>
1500 x 700 x 900	57	<b>MH215CD</b>	<b>MH215CG</b>	69.5	<b>MH315CD</b>
1600 x 700 x 900	60	<b>MH216CD</b>	<b>MH216CG</b>	73	<b>MH316CD</b>
1800 x 700 x 900	66	<b>MH218CD</b>	<b>MH218CG</b>	81	<b>MH318CD</b>
2000 x 700 x 900	72	<b>MH220CD</b>	<b>MH220CG</b>	89	<b>MH320CD</b>

 Shipping within 48h

## Chef furniture with rounded edge



**MH2-14CD + PLAROBIML**  
(tap p. 60)

### Customized

HEIGHT 900 mm	SINGLE PANEL DOORS AND SIDES	WITH DOUBLE PANEL DOORS AND SIDES
<b>WIDTH 700</b>		
Length mm	Ref.	Ref.
900 to 1000	<b>MH2-10C</b>	<b>MH3-10C</b>
1001 to 1200	<b>MH2-12C</b>	<b>MH3-12C</b>
1201 to 1400	<b>MH2-14C</b>	<b>MH3-14C</b>
1401 to 1600	<b>MH2-16C</b>	<b>MH3-16C</b>
1601 to 1800	<b>MH2-18C</b>	<b>MH3-18C</b>
1801 to 2000	<b>MH2-20C</b>	<b>MH3-20C</b>
2001 to 2200	<b>MH2-22C</b>	<b>MH3-22C</b>

*Sink on the right or on the left, please notify on the order*

**MH214CD + POPT16**



## Options for Chef furniture

Designation	Ref.
4 stainless steel feet H 155 mm - Add X to the end of the reference	<b>.../X</b>
4 stainless steel castors Ø 125 mm (2 with brake) - Add RX to the end of the reference	<b>.../RX</b>
Extra cost for interior fittings (bottom shelf + partition) for Chef furniture	<b>POPT16</b>

**OPTIONS**  
pages 58-59



**ACCESSORIES**  
page 60





## Rounded edge can opening tables on feet



TAB2CD

- Work top: in AISI 304L 1.5 mm thickness stainless steel, reinforced with a 19 mm thick water-resistant melamine panel
- Tubular legs: in stainless steel Ø 38 mm, with levellers adjustable up to 30 mm - connected by 4 stainless steel panels
- 20 mm rounded edge radius , 60 mm drop edge, welded corners
- Rear backsplash 100 x 20 mm , rounded 10 mm at the base and with a 30° slope edge, 10mm curve (optional: rear closed)
- Pressed sink: designed for 2, 3 or 4 gastro 1/1 sinks 200 mm deep - Drainage on the front
- With work top on the right or the left side for can or tin opener

### Standard

SINK	TO RECEIVE:	HEIGHT 900 mm	SINK ON THE RIGHT		SINK ON THE LEFT		ROUNDED EDGE BOTTOM SHELF, optional	
			Ref.	Ref.	Kg	Ref.		
L x D x H mm		L x D mm	Kg	Ref.	Ref.	Kg	Ref.	
630 x 510 x 215	2 GN 1/1 trays	1200 x 700	39	TAB2CD	TAB2CG	7	EGA710	
960 x 510 x 215	3 GN 1/1 trays	1500 x 700	47	TAB3CD	TAB3CG	8	EGA712	
1290 x 510 x 215	4 GN 1/1 trays	1800 x 700	56	TAB4CD	TAB4CG	11	EGA716	

**+** Especially designed for perforated gastronorm trays for straining tinned food. Offset feet to fix the tin opener.

**OPTIONS** pages 58-59

**ACCESSORIES** page 60

## Suspended and semi-suspended can opening tables

### Same as can opening tables on feet except:

- Frame in bent stainless steel round tubes Ø 38 mm
- Frame fixed to the wall by screwing through the wall plates
- Top attaches to the wall by screwing of the rear profile

### Semi-suspended version:

- Frames in bent round tube Ø 38 mm with welded set-back front leg
- ABS feet adjustable up to 30 mm



### Standard

SUSPENDED CAN OPENING TABLES				SEMI-SUSPENDED CAN OPENING TABLES			
L x D mm	TO RECEIVE:	Kg	SINK ON THE RIGHT	SINK ON THE LEFT	Kg	SINK ON THE RIGHT	SINK ON THE LEFT
			Ref.	Ref.		Ref.	Ref.
1200 x 700	2 GN 1/1 trays	37	TASB2CD	TASB2CG	38	TASSB2CD	TASSB2CG
1500 x 700	3 GN 1/1 trays	45	TASB3CD	TASB3CG	46	TASSB3CD	TASSB3CG
1800 x 700	4 GN 1/1 trays	54	TASB4CD	TASB4CG	55	TASSB4CD	TASSB4CG

## Can opening tables

### Customized

- 4 feet (6 feet from length 2200 mm)
- Tap hole Ø 31 mm (optional cover)
- Sink on the right or on the left, please notify on the order

**i** > Stainless steel panels on the front and both sides for customized can opening tables : option POPT04 page 58  
 > Suspended or semi-suspended can opening tables : options TOP16 or TOP17 page 58

HEIGHT 900 mm		Sink:	Sink:	Sink:
		630 X 510 X H 215 MM FOR 2 TRAYS GN 1/1	960 X 510 X H 215 MM FOR 3 TRAYS GN 1/1	1290 X 510 X H 215 MM FOR 4 TRAYS GN 1/1
<b>WIDTH 700</b>				
Length mm	Legs	Ref.	Ref.	Ref.
1000 to 1200	4	TAB2-12	-	-
1201 to 1400	4	TAB2-14	-	-
1401 to 1600	4	TAB2-16	TAB3-16	-
1601 to 1800	4	TAB2-18	TAB3-18	-
1801 to 2000	4	TAB2-20	TAB3-20	TAB4-20
2001 to 2200	4	TAB2-22	TAB3-22	TAB4-22
2201 to 2400	6	TAB2-24	TAB3-24	TAB4-24
2401 to 2600	6	TAB2-26	TAB3-26	TAB4-26

CUSTOMIZED ROUNDED EDGE BOTTOM SHELF, optional
Ref.
EGA7-10
EGA7-12
EGA7-14
EGA7-16
EGA7-18
EGA7-20
EGA7-22
EGA7-24



## TABLES | ROUNDED EDGE TABLES

### Stainless steel table with adjustable height

**ADJUS'TABLE**<sup>®</sup>  
THE HEIGHT OF WELL-BEING



Electric push button : a simple pressure is enough to change the height, no effort to make!



- Adaptable to the user's height
- Eliminates musculoskeletal disorders
- Reduces work stress
- Suitable for people with reduced mobility
- Up and down control by electric push button



**SCAN ME**  
for the video demonstration!

*Adjus'table can be adjusted to suit tall people, short people and people with reduced mobility and allows to work at the right height without pain thanks to its electric adjustment system.*

- All-stainless table
- Table top thickness 1.5 mm, reinforced with water-resistant 19 mm melamine panel
- Grooved table top: 20 mm groove front and rear, 60 mm drop edge
- 40 x 40 mm stainless steel square feet
- Adjustable height by adjustable legs with stainless steel rod
- Height adjustable from 700 mm to 1100 mm
- Up and down control by push button on the side trim
- Plugs in to the mains (single phase 230V - 50 or 60 Hz)
- Supports weight: 200 kg
- Proven reliability and robustness (10 000 cycles)
- Anti-crushing option for the disabled person range
- 1 year warranty
- On adjustable legs - Optionally on castors

**SPECIAL BAKERY THV WITH WOOD TOP**  
*Please consult us*





## Stainless steel table with adjustable height

PRM means Persons with Reduced Mobility

FOR TABLES WITH PRM OPTION ONLY :

- A sensitive detector located under the table top at the front stops the up or down movement of the table at a distance of 10 mm if an obstacle is detected.

### Adjus'table tables



THVD16



THVP16

#### WITHOUT PRM OPTION

L x D mm	CENTRAL		WITH BACKSPLASH	
	Kg	Ref.	Kg	Ref.
1200 x 700	66	THV12	67	THVD12
1400 x 700	70	THV14	71	THVD14
1500 x 700	72	THV15	73	THVD15
1600 x 700	74	THV16	75	THVD16
1800 x 700	78	THV18	79	THVD18
2000 x 700	82	THV20	83	THVD20

#### WITH PRM OPTION

Kg	CENTRAL		WITH BACKSPLASH	
	Ref.	Kg	Ref.	Kg
66	THVP12	67	THVDP12	
70	THVP14	71	THVDP14	
72	THVP15	73	THVDP15	
74	THVP16	75	THVDP16	
78	THVP18	79	THVDP18	
82	THVP20	83	THVDP20	

### Adjus'table Chef tables

- All-stainless sink 400 x 400 x 250 mm
- Supplied with plug, simple overflow pipe and U bend.



THVH16G

THVHP16G



#### WITHOUT PRM OPTION

L x D mm	Kg	SINK ON THE RIGHT	SINK ON THE LEFT
		Ref.	Ref.
1600 x 700	76	THVH16D	THVH16G
1800 x 700	80	THVH18D	THVH18G
2000 x 700	84	THVH20D	THVH20G

#### WITH PRM OPTION

SINK ON THE RIGHT	SINK ON THE LEFT
THVHP16D	THVHP16G
THVHP18D	THVHP18G
THVHP20D	THVHP20G

### Options for Adjus'table tables

The adding of castors changes the amplitude of the table from 825 mm minimum to 1225 mm maximum (instead of 700 to 1000 mm for models on cylinders)

ACCESSORIES  
page 60



Designation	Ref.
4 stainless steel castors (2 with brake) - Add RX to the end of the reference	.../RX
4 polyamid castors (2 with brake) - Add RP to the end of the reference	.../RP



# TABLES | ROUNDED EDGE TABLES

## Table shelves

- Shelf: stainless steel
- Legs: Ø 38 mm tubular stainless steel
- To be fixed where you want on the worktop - delivered with drilling templates
- 1st level: 400 mm from the worktop
- 2nd level: 600 mm from the worktop



FOR TABLE	SHELF	1 SHELF (H 400 MM)		2 SHELVES (H 600 MM)	
		Kg	Ref.	Kg	Ref.
Length mm	L x W mm				
1000	960 x 300	5.5	<b>EGS110</b>	11.7	<b>EGS210</b>
1200	1160 x 300	6.5	<b>EGS112</b>	13.3	<b>EGS212</b>
1400	1360 x 300	7.5	<b>EGS114</b>	14.9	<b>EGS214</b>
1500	1460 x 300	7.5	<b>EGS115</b>	16	<b>EGS215</b>
1600	1560 x 300	8	<b>EGS116</b>	16.6	<b>EGS216</b>
1800	1760 x 300	9.5	<b>EGS118</b>	19	<b>EGS218</b>
2000	1960 x 300	11	<b>EGS120</b>	22	<b>EGS220</b>

Shipping within 48h

OPTION : Stainless steel angles	Ref.
Set of 4 angles with stud, for fixing EGS shelf on the lateral side of a top (for fixation on existing element for example)	<b>EGSCOR</b>

➤ **CUSTOMIZED** / Different lengths, +15 % of the price of the standard lower length (max. 2200)

**+** 1 or 2 shelf levels  
**Round legs, suitable for collapsible tables.**  
**Space saving:** frees up the entire worktop surface, can be used as a serving hatch on a central table

## Drawers for collapsible tables

- Telescopic runners in stainless steel
- Fits on collapsible tables with straight or rounded edges
- Max. load per drawer: 5kg in use
- Fixing with screws

**+** Strengthened drawers  
 All stainless steel runners

Designation	L x D x H mm	Kg	Ref.
<b>Drawer for table depth 600</b> + 1 GN2/3 stainless steel tray - 100mm high	370 x 467 x 127	6	<b>TTIRG06</b>
<b>Drawer for table depth 700</b> + 1 GN1/1 stainless steel tray - 100mm high	370 x 567 x 127	8	<b>TTIRG10B</b>
<b>Drawer for table depth 800</b> + 1 GN1/1 stainless steel tray - 100mm high	370 x 667 x 127	8.5	<b>TTIRG08</b>

Shipping within 48h



## Set of 3 x GN1/1 drawers hanging unit

- For collapsible tables only 700 mm deep and length upper than 1000 mm
- Recessed handles
- Supplied with 3 x GN1/1 gastronorm containers with depth 100 mm
- On stainless steel runners



**TAD712 (see page 38) + 1 TTIR3G10B**



Installing a bottom shelf under the table is not compatible with the TTIR3G10B 3-drawer unit.

FOR 700 MM WIDE TABLES		
L x D x H mm	Kg	Ref.
420 x 583 x 556	24	<b>TTIR3G10B</b>



## Preparation table

- Top in AISI 304L stainless steel, reinforced with a 19 mm thick melamine panel, with special lateral profiles for the sliding track
- 1 x GN2/1 stainless steel grid sliding on 2 polyethylene runners
- 35 x 35 mm and 35 x 20 mm tubular stainless steel legs on 4 Ø 125 mm swivelling polyamide castors, 2 with brake.



L x D x H mm	Kg	Ref.
1800 x 750 x 900	57	<b>TGR718</b>



Hygiene, robustness and ergonomics are the main advantages of this table, specially designed for setting out hors d'oeuvres, salads and pastries in series.

Mounted on swivelling castors, this clever table fits into any kitchen. It is equipped with a sliding griddle on which to place the gastronomic containers containing the ingredients, which can then be slid over the plates as they are plated up.

**The result: less handling, ergonomic working conditions and significant time savings!**

# Stainless steel, the material of chefs

## The specificity of stainless steel

When exposed to moisture in the air or water, steel rusts, unlike stainless steel, which contains chromium.

With the exception of precious metals such as gold or platinum, all metals are extracted from ore. Over time, they therefore tend to return to their original state, i.e. oxides.

Passive film = protective layer

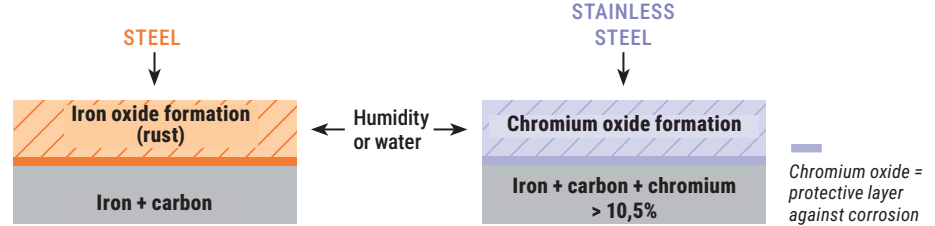

Because steel does not contain chromium, on contact with moist air or water, an iron oxide called rust is formed on the surface.

Conversely, because it contains chromium, a protective layer of chromium oxide called a passive film forms naturally on the surface of stainless steel, protecting it from corrosion.



Around the world, the vast majority of professional kitchen equipment is made of stainless steel, an ideal material due to its many properties.

- Food
- Hygienic
- Heat resistant
- Shock resistant
- Aesthetics
- Cleanable
- Corrosion resistant
- Sustainable



## How to extend the life of your stainless steel equipment?

Regular maintenance helps to preserve the original appearance of stainless steel and ensure its resistance to corrosion.

### ✓ Maintenance

- Clean and rinse regularly with WATER
- Dry after use
- **Use suitable products:** water and mild soap, a soft sponge or cloth, white vinegar, a cleaner specifically formulated for stainless steel
- Use plastic or wooden utensils to avoid damaging surfaces

### ✗ Caution!

- Do not use ABRASIVE products such as sponges or metal brushes
- Do not use concentrated and/or hot bleach or chlorine
- Do not allow acidic liquids to remain in contact with stainless steel
- Do not use wax or polishing agents
- Do not use sharp objects or hard metal objects



# Options for standard and customized tables

Std : standard,  
CM : customized,  
Chef and Can : Chef table and can opening table.

FOR TABLES WITH

Designation	STRAIGHT EDGES		ROUNDED EDGES			Ref.
	Std & CM	Std	CM	Chef & Can CM		
<b>Legs / feet &amp; castors</b>						
4 stainless steel feet - Add "X" to the end of the reference	✓	✓	✓	✓	✓	.../X
6 stainless steel feet (for length upper than 2200 mm) - Add "X" to the end of the reference		✓	✓	✓	✓	.../X
2 stainless steel feet for semi-suspended table - Add "X" to the end of the reference		✓	✓	✓	✓	.../X
4 stainless steel castors Ø 125 mm (2 with brake) - Add "RX" to the end of the reference	✓	✓	✓	✓	✓	.../RX
6 stainless steel castors Ø 125 mm (2 with brake) for length upper than 2200 mm - Add "RX" to the end of the reference	✓	✓	✓	✓	✓	.../RX
4 polyamid castors Ø 125 mm (2 with brake) - Add "RP" to the end of the reference	✓	✓	✓	✓	✓	.../RP
6 polyamid castors Ø 125 mm (2 with brake) for length upper than 2200 mm - Add "RP" to the end of the reference	✓	✓	✓	✓	✓	.../RP
<b>Semi-mobile option</b> For tables legs upper than 2200 mm (3 castors + 3 feet), prices x 1,5		✓	✓	✓	✓	.../SMP
2 castors polyamid cover without brake et 2 ABS feet - Add "SMP" to the end of the reference.	✓	✓	✓	✓	✓	.../SMP
2 castors stainless cover without brake and 2 stainless steel feet - Add "SMX" to the end of the reference	✓	✓	✓	✓	✓	.../SMX
<b>Added value for special height legs for standard table.</b> For tray height 1050 mm maxi (otherwise consult us). Specify the desired height of the material when ordering.	Std	✓				.../SPHT
<b>Supplement for 2 hanging consoles on customized table</b> (supplement to add to the price of a table on 4 ABS adjustable legs) - 3 consoles upper than 2200 mm, price x1,5				✓	✓	TOP16
<b>Supplement for 2 semi hanging consoles on customized table</b> (supplement to add to the price of a table on 4 ABS adjustable legs) - 3 consoles upper than 2200 mm, price x1,5				✓	✓	TOP17
<b>Structure &amp; reinforcement</b>						
<b>Lateral and longitudinal bottom crosspieces</b> (U or H shape: please notify on the order) - Option non available on suspended and semi-suspended tables. For tables with 6 feet, prices x 1,5.		✓	✓	✓	✓	TRAV
<b>4 feet welded on the side strips</b> For tables with 6 feet, prices x 1,5		✓	✓	✓	✓	SPSOUD
<b>Panels &amp; trims</b>						
<b>Stainless steel panels (3 faces)</b> for standard chef table and can opening table on 4 feet (package)	Chef	Chef & Can				TOP14
<b>Stainless steel panels (3 faces)</b> for standard suspended and semi-suspended tables		Chef & Can				TOP15
<b>Stainless steel panels (3 faces)</b> for customized chef table on feet or hanging (the linear metre of frontage, minimum 1 m)				✓		POPT04
<b>Knee operated</b> - Delivered with front panel with premixer, sawn neck and push tap (option only available on chef table with sink cover option)		Chef & Can		✓		CEAUV

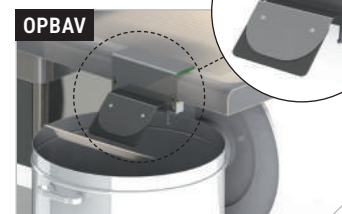



# Options for standard and customized tables

Std : standard,  
 CM : customized,  
 Chef and Can : Chef table and can opening table.

FOR TABLES WITH

Designation		STRAIGHT EDGES		ROUNDED EDGES			Ref.
		Std & CM	Std	CM	Chef & Can CM		
<b>Backsplashes</b>							
Rear backsplash closure (package)		✓	✓	✓	✓		TFD
Rear backsplash height 300 mm (per lm, minimum 1 lm)				✓	✓		TOP12
Manufactured side backsplash 100 x 20 mm integrated on the worktop. Possibility of adding 2 side sheet metal backsplashes up to 2700 mm. Warning, only 1 side sheet metal backsplash from 2701 to 2800 mm max.					✓	✓	TDL
Side raised backsplash : Welded and siliconed, rear not closed	For tables width 600 mm	On the right	Std				TTDR610D
		On the left	Std				TTDR610G
	For tables width 700 mm	On the right	Std				TTDR710D
		On the left	Std				TTDR710G
Side raised backsplash : SWelded and siliconed, rear not closed	For tables width 600 mm	On the right		✓			TTDR610AD
		On the left		✓			TTDR610AG
	For tables width 700 mm	On the right		✓			TTDR710AD
		On the left		✓			TTDR710AG
<b>Bumpers &amp; protections</b>							
Rear bumpers : 2 rear bumpers in AISI 304L stainless steel with soldered 25x25 section on the back of tables with backsplash - Wall protected by 2 black ABS stops - 35 mm gap between backsplash and wall for easier cleaning		✓		✓	✓	✓	TTBA2
Corner bumpers : Set of 4 corner bumpers fixed on the corners of the central table For tables with backsplash, add the TFD option		✓		✓	✓	✓	TTCP4
Rubber squeegee / bib fixed on table to empty the plates (trash cans below)		✓		✓	✓	✓	OPBAV
<b>Tap hole(s)</b>							
Table without tap hole				Chef & Can		✓	SPST
Table with 2 tap holes				Chef & Can		✓	SPBT
<b>Cut-out and finishing of the worktop (check feasibility with our teams before costing)</b>							
Tray thickness 2 mm instead of 1.5 mm (per lm, minimum 1 lm)					✓	✓	TOP11
Cut-out for post for central table					✓	✓	TOP01
Special cut-out in corner					✓	✓	TOP02
Rectangular cut-out in the worktop					✓	✓	TOP03
Angle-cut corner					✓	✓	TOP04
Cut-out for post in corner with backsplash					✓	✓	TOP05
Cut-out for post with backsplash For table with backsplash					✓	✓	TOP06
Vibrated polishing (in circles) (per lm, minimum 1 lm)	Central table				✓	✓	TOP09
	Table with backsplash				✓	✓	TOP10
Waste hole With rubber plug Ø 165 mm		CM			✓	✓	TTVDC

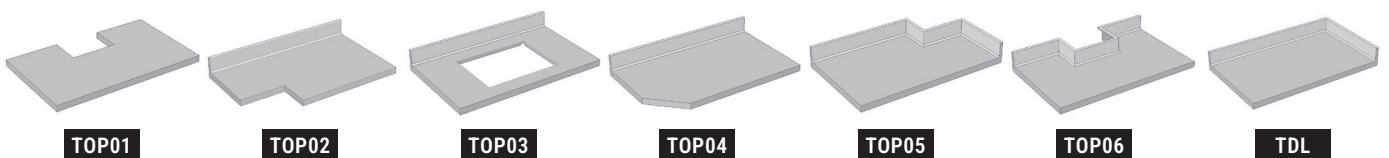



# Accessories for standard and customized tables

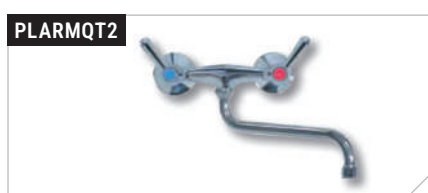
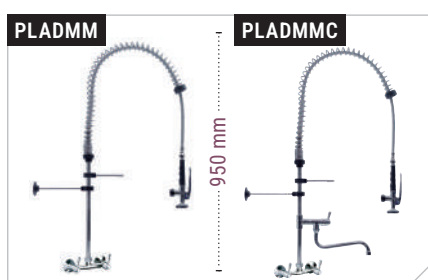
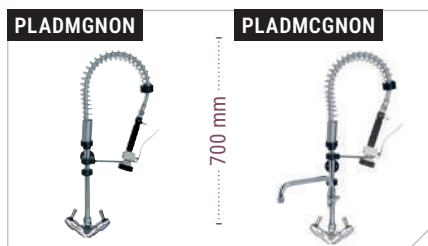
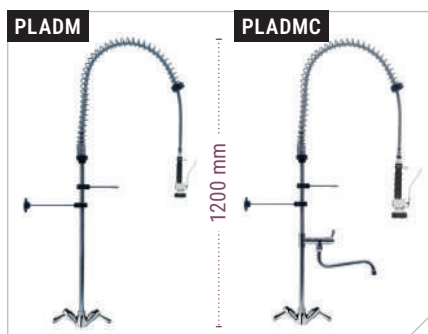

Designation		Ref.		
<b>Faucet to fix on sink</b>				
<b>Mixer spray-heads to fix on sink - Height 1200 mm</b>				
Fixed to the table + wall fixing bracket - Stainless steel AISI 304L - Mixer with non-return valves according to European standard EN13959 - Safety spring - Flexible I. 1200 mm in AISI 304L stainless steel braid + EPDM standard, nd 12.5 - Flow rate in liters per minute for a pressure of 3/4 bars: 17 l/ min - Total height: 1200 mm - Ergonomic grips with turn valve head - HW/CW taps with high-quality ceramic head - Spray head in stainless steel interior according to European standards CE, ROHS and ACS				
Without drawing tap		<b>PLADM</b>		
With drawing tap with swivel telescopic spout		<b>PLADMC</b>		
<b>Mixer spray-heads Mignon model - Height 700 mm</b>				
Ideal to go under the wall cabinets				
Without drawing tap		<b>PLADMGNON</b>		
With drawing tap with swivel telescopic spout		<b>PLADMCGNON</b>		
1/4 turn tap : Single hole with swan's neck		<b>PLARQT1</b>		
Mixer tap : Single hole		<b>PLAROBIML</b>		
<b>Wall faucet</b>				
<b>Wall mixer spray-heads</b>				
Idem PLADMC except : wall fixation, height 950 mm				
Without drawing tap		<b>PLADMM</b>		
With drawing tap with swivel telescopic spout		<b>PLADMMC</b>		
<b>Wall mixer taps</b>				
Twin-hole - 1/4 turn - Wall fixation - Spout length 250 mm				
Swivel spout from below		<b>PLARMQT2</b>		
Swivel spout from above		<b>PLARMQT3</b>		
Chromed cover : For the tap hole		<b>CT50</b>		
<b>U bends</b>				
PVC		<b>PLASIPHPL</b>		
Chromed brass		<b>PLASIPHLA</b>		
<b>Plug</b>				
Perforated overflow pipe* : Makes catching waste easier and prevents the risk of the U bend getting blocked		H180 mm	<b>POPTUB18</b>	<b>POPTUBPL18</b>
		H230 mm	<b>POPTUB23</b>	<b>POPTUBPL23</b>
		H280 mm	<b>POPTUB28</b>	<b>POPTUBPL28</b>
		H350 mm	<b>POPTUB35</b>	<b>POPTUBPL35</b>
		H430 mm	<b>POPTUB43</b>	<b>POPTUBPL43</b>
<b>Wall mounted detergent dispenser : Spring pump with automatic refill - Adjustable and secure dosage of 5 to 30 cc by pressure - Polypropylene body - Valves - ABS push button - Wall mounting and maintenance completely without tools</b>				
		<b>PLSAV</b>		
<b>Straight sink exhaust pipe without tap** : Tubular Ø 42,4 mm without valve - Non available on sink with integral bottom shelf</b>				
Simple		<b>PLAVISV*</b>		
Double Y		<b>PLAVIDSV*</b>		
<b>Straight sink exhaust pipe with tap(s)** : With 1/4 40 x 49 female turn(s) and AISI 304L stainless steel outlet pipe(s) (distance from floor about 80 mm depending on) - Non available on sink with integral bottom shelf</b>				
Simple		<b>PLAVI*</b>		
Double Y		<b>PLAVID*</b>		